

# LED Corn Lights

## LED Retrofit - Lampe

Ersatz für 50 - 400 Watt HQL-Lampen  
50 - 250 Watt NAV Lampen



IP 40

130 lm/W

klar

## HG-CBH-SxxW Serie

27W - 36W - 54W - 75W - 95W - 115W  
E27/E40

### Geeignet zum Betrieb:

- an Netzspannung (230V)
- LED-Treiber integriert
- Patentiertes Gehäuse-Design zur Wärmeabführung
- Lampensockel bis 270° verstellbar
- Abstrahlwinkel der LED-Chips 90 x 150°
- Perfekte Lichtverteilung durch individuelle Linsen pro LED-Chip
- Lebensdauer: 50.000 h LM 80
- 5 Jahre Garantie, 180° Abstrahlwinkel, 130 lm/W
- CE, RoHS
- Passive Kühlung 27W / 36W
- Aktive Kühlung 54W / 75W / 95W / 115W

**Spezifikation:**

Produktname	HG-CBH-S27W	HG-CBH-S36W	HG-CBH-S54W	HG-CBH-S75W	HG-CBH-S95W	HG-CBH-S115W
Nennleistung	27 W	36 W	54 W	75 W	95 W	115 W
Eingangsspannung	AC 100~240V(50~60Hz)					
Farbtemperatur	2.200 ~ 6.500 K					
Leistungsfaktor	0.90					
Farbwiedergabe	>70 Ra					
Lichtstrom	3.500 lm	4.700 lm	7.000 lm	9.700 lm	12.300 lm	15.000 lm
LED Anzahl	56 Stück	84 Stück	112 Stück	140 Stück	168 Stück	196 Stück
Sockel	E27 / E40			E40		
Gehäusetemperatur	60 °C					
Arbeitstemperatur	-20 ~ +50 °C					
Lagertemperatur	-30 ~ +80 °C					
Strahlungswinkel	90 * 150 °					
IP-Bewertung	IP40					
Kühlung	Passiv			Aktiv		
Abmessungen	233 * 113 * 80 mm			297 * 138 * 87 mm		
Nettogewicht	720 g	720 g	750 g	1.280 g	1.280 g	1.310 g
LED Abdeckung	Standard klar					
Zertifikate	CE RoHS					

**Installation:**

Versorgungseinheit z.B.:

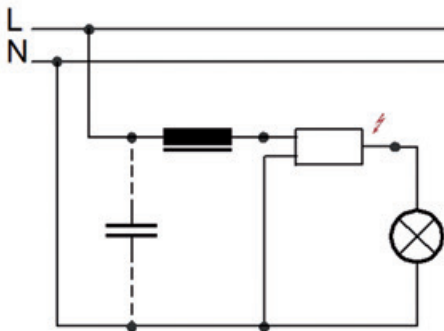

Anpassen:

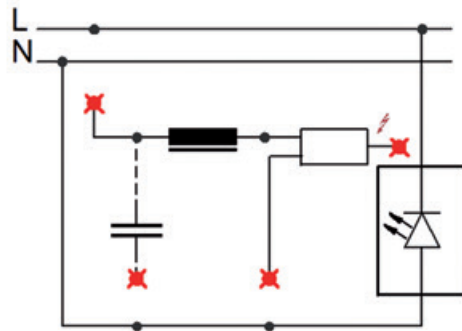

Neuinstallation

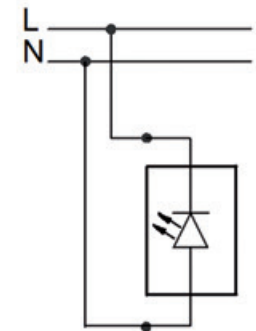

LED Corn Light CBH-SxxW 200101.pdf

**Eigenschaften:**

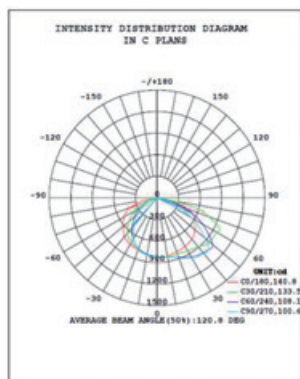

27W

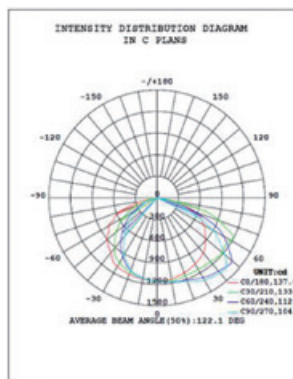

36W

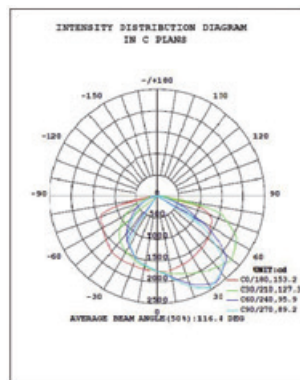

54W

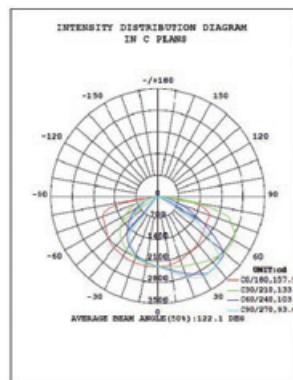

75W

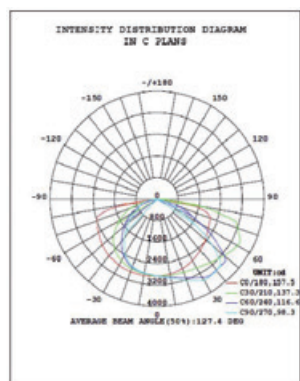

95W

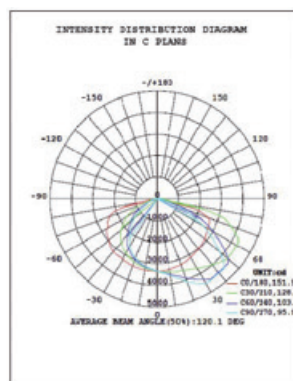

115W

LED Corn Light CBH-SxxW 200101.pdf